



Total Solutions for  
Productivity  
Achievement

# FACTORY AUTOMATION SOLUTIONS



[www.tpa.com.vn](http://www.tpa.com.vn)

**Tanphat Automation JSC (TPA)**, a subsidiary of Tanphat Equipment JSC, is a system integrator established in 2006 focused on design, manufacturing & supplying equipment and system for Industry and Training. Mainly our customers are Japanese and Korean Factories and Vocational Institutes. We have employees experienced in customer service, project management, industrial technology, electrical and mechanical design and assembly. Intelligent Solutions with cost optimization, stability of machines and local support services are our target always.

**Establishment Year:** 2006

**Factory Address:** No 168, Phan Trong Tue Road, Thanh Liet Ward, Thanh Tri Dist, Hanoi

**Main Technology:** Vision, Robotics, PCB Design, Mechanical & Electrical Design.

**Certificate:** ISO 9001:2008 , CE 12601:2001

### Organization:

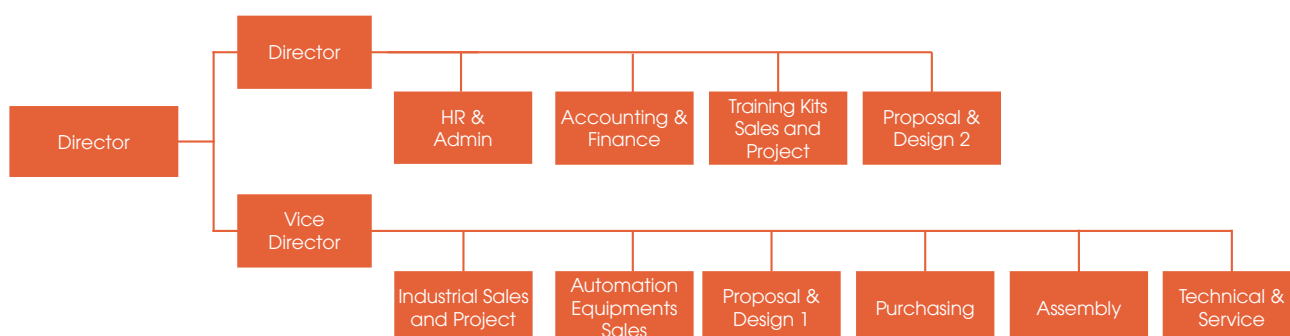

**Turnover**  
(USD Million)

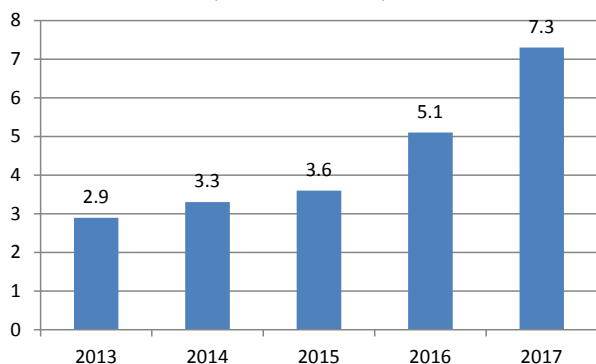

**Number of Employees**

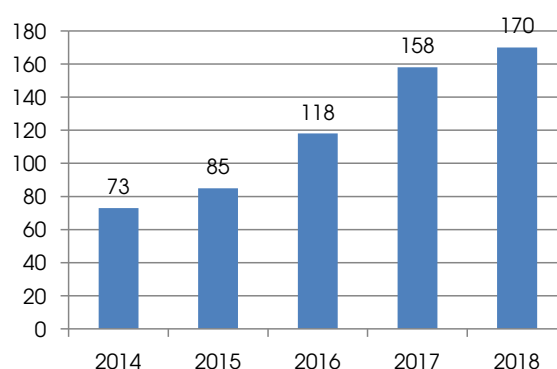

## 1. Office



## 2. Assembly Workshop



Assembly Workshop







Machine Assembly



Machine Assembly



Part Assembly

No	Products	Application	Segments
1	<p><b>FACTORY AUTOMATION SOLUTIONS</b></p> 	<ul style="list-style-type: none"> <li>• Parts Feeding</li> <li>• Sorting</li> <li>• Assembly</li> <li>• Measuring</li> <li>• Soldering</li> <li>• Pick and Place</li> <li>• Packing &amp; Palletizing</li> <li>• Robot Integrated</li> <li>• Vision</li> </ul>	<ul style="list-style-type: none"> <li>• Electronics</li> <li>• Automotive Parts</li> <li>• Metal Fabrication</li> <li>• Home Appliance</li> <li>• FMCG</li> <li>• Pharmacy</li> </ul>
2	<p><b>ROBOTICS APPLICATIONS</b></p> 	<ul style="list-style-type: none"> <li>• Machine Tending</li> <li>• Sand/Ball Blasting</li> <li>• Assembly</li> <li>• Dispensing</li> <li>• Pick and Place</li> <li>• Packing &amp; Palletizing</li> <li>• Grinding &amp; Polishing</li> <li>• Loading / Unloading</li> <li>• Collaborative Robots</li> </ul>	<ul style="list-style-type: none"> <li>• Electronics</li> <li>• Automotive Parts</li> <li>• Metal Fabrication</li> <li>• Home Appliance</li> <li>• FMCG</li> <li>• Pharmacy</li> </ul>
3	<p><b>VISION</b></p> 	<ul style="list-style-type: none"> <li>• Inspection</li> <li>• Guide/Align</li> <li>• Gauge/Measure</li> <li>• OCR/OCV</li> <li>• Presence/Absence</li> <li>• Code Reading</li> </ul>	<ul style="list-style-type: none"> <li>• Electronics</li> <li>• Automotive Parts</li> <li>• Metal Fabrication</li> <li>• Home Appliance</li> <li>• FMCG</li> <li>• Pharmacy</li> </ul>
4	<p><b>AUTOMATION EQUIPMENT</b> (Collaborative Robots, Camera vision, Data Man, Conveyor, Dispenser, Printer, AGV...)</p> 	<ul style="list-style-type: none"> <li>• Assembly</li> <li>• Machine tending</li> <li>• Packaging and Palletizing</li> <li>• Gluing, Dispensing, and Welding</li> <li>• Injection Molding</li> <li>• Pick and Place</li> <li>• Conveyor system</li> <li>• Spiral Elevator</li> <li>• Plastic Chain Conveyor</li> <li>• Incline Conveyor</li> <li>• PCB Handling</li> <li>• System Integration</li> <li>• Consumer Products</li> <li>• Packaging</li> <li>• Consumer</li> <li>• Chemistry</li> <li>• Pharma</li> <li>• Raw material transfer</li> <li>• Station on the car</li> <li>• Conveyor Finished Goods</li> </ul>	<ul style="list-style-type: none"> <li>• Electronics</li> <li>• Automotive Parts</li> <li>• Metal Fabrication</li> <li>• Home Appliance</li> <li>• FMCG</li> <li>• Pharmacy</li> </ul>

## PARTNERS

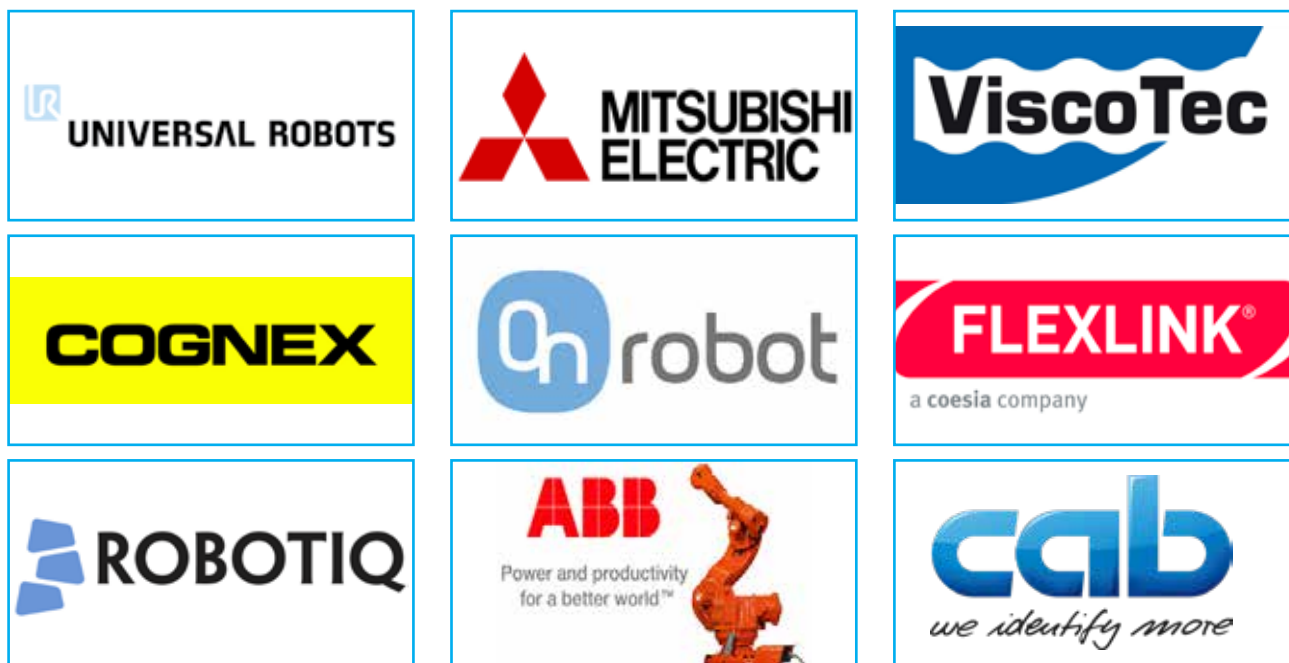

## CUSTOMERS





Parts Feeding Solutions



Sorting Solutions

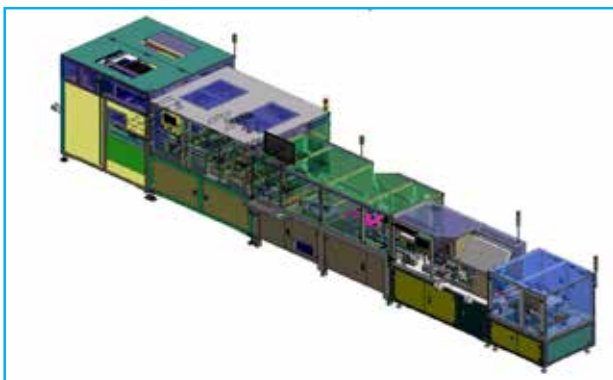

Assembly Solutions

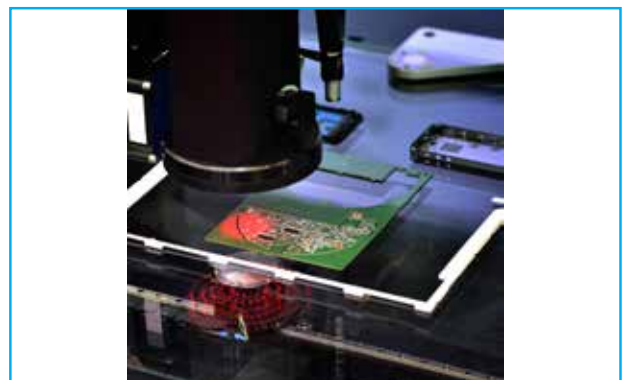

Measuring Solutions



Soldering Solutions



Painting Solution

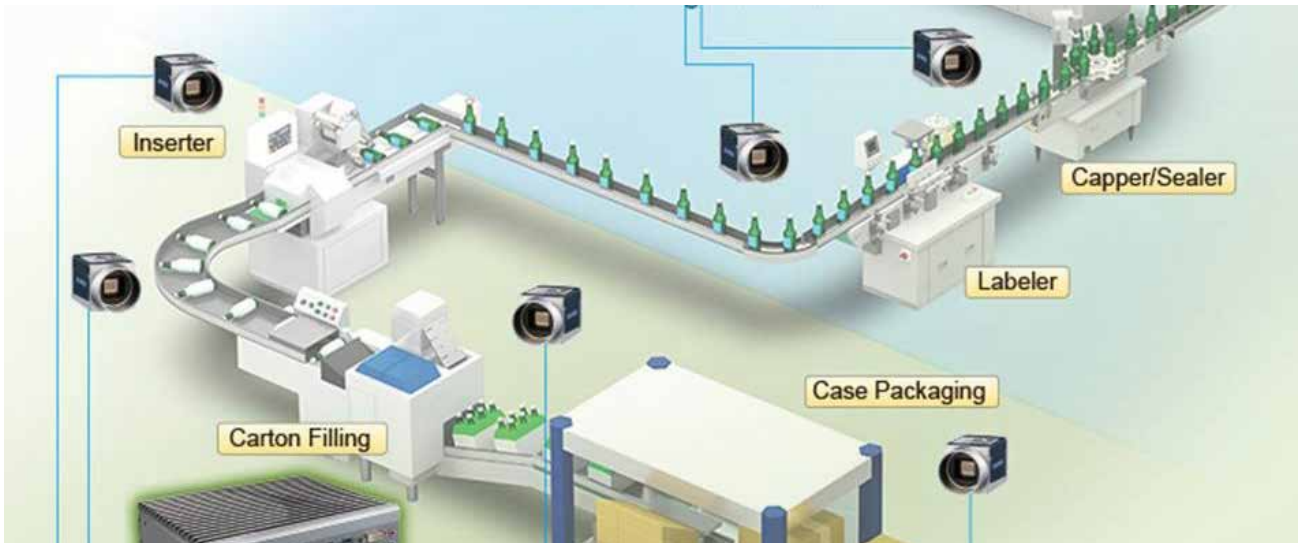

Inspection



Guide/Align

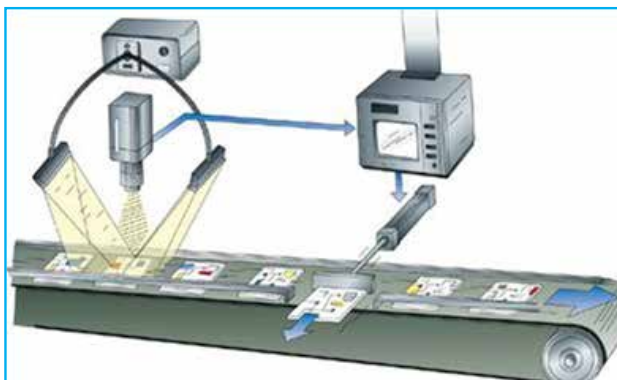

Gauge/Measure



OCR/OCV



Presence/Absence



Code Reading

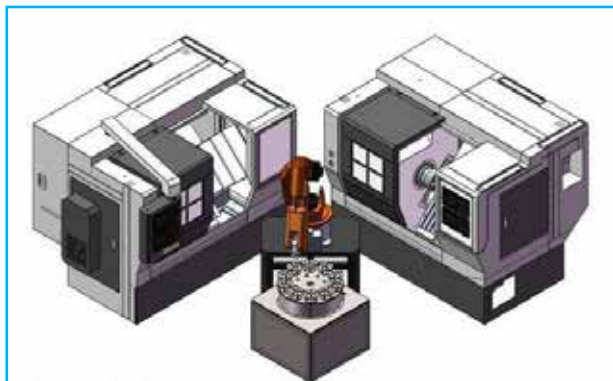

Machines Tending

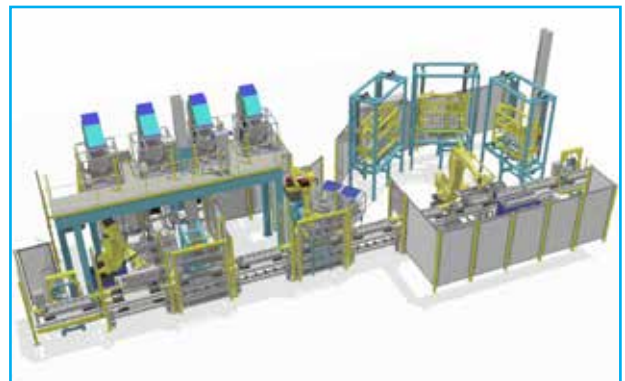

Robotic Assembly line



Robotics Pick and Place



Robotics Packing and Palletizing



Robotic Painting

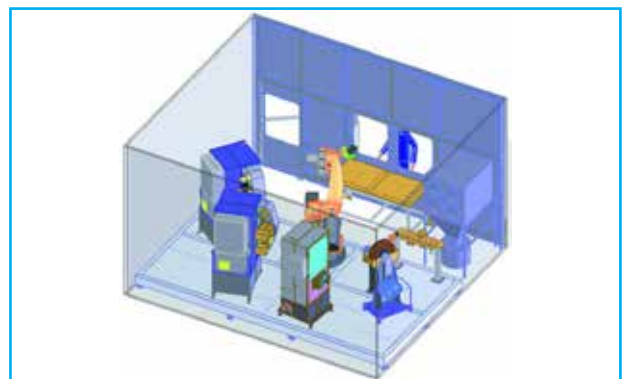

Grinding & Polishing





Pressing Machine



Pressing Machine



Inspection Appearance



Outside Inspection Machines



Auto Pasting Line



Semi cutting machine



Forming machine



Assembly Lines



Auto Pasting machine



Parts Assembly Lines

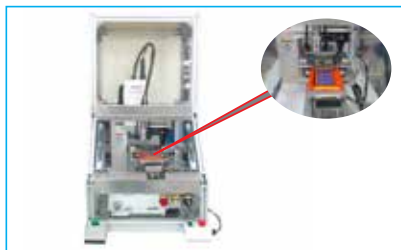

Router Cutting Machines



Cleaning Machines



Laser Cutting Machines



Auto Inspection/Electric Testing and Boxing



Cell Phone Speaker Inspection Machines



Tube Marking Machines



Autogas Charging Machines



Assembly System

## Universal Robots



## Flexlink



## CAB Printer



## Cognex



## Soldering Robot



## Dispenser Viscotec



## CONTACT US



Total Solutions for  
Productivity  
Achievement

### TAN PHAT AUTOMATION JSC

Tel: (+84) 24 3685 7776 | Fax: (+84) 24 3685 7775 | Email: [info@tpa.com.vn](mailto:info@tpa.com.vn)  
Add: 168- Phan Trong Tue Road, Thanh Liet Ward, Thanh Tri Dist, Ha Noi, Viet Nam

[www.tpa.com.vn](http://www.tpa.com.vn)

